

5W – Coaxial Attenuator

Design Features

- ◆ High RF performance, ultra-competitive price.
- ◆ Custom design available upon request.
- ◆ Military, space and commercial applications.
- ◆ Guaranteed for one year standard.

RF Characteristics

Model Number	Freq. Range	Power	Attenuation Value	Attenuation Tolerance	VSWR Max	Connector Type	Impedance
UIYCA5AN3A1	DC-3GHz	5W	1 dB	±0.5 dB	1.2	N-M / N-F	50 Ω
UIYCA5AN3A2	DC-3GHz	5W	2 dB	±0.5 dB	1.2	N-M / N-F	50 Ω
UIYCA5AN3A3	DC-3GHz	5W	3 dB	±0.5 dB	1.2	N-M / N-F	50 Ω
UIYCA5AN3A5	DC-3GHz	5W	5 dB	±0.5 dB	1.2	N-M / N-F	50 Ω
UIYCA5AN3A6	DC-3GHz	5W	6 dB	±0.5 dB	1.2	N-M / N-F	50 Ω
UIYCA5AN3A10	DC-3GHz	5W	10 dB	±0.6 dB	1.2	N-M / N-F	50 Ω
UIYCA5AN3A20	DC-3GHz	5W	20 dB	±0.8 dB	1.2	N-M / N-F	50 Ω
UIYCA5AN3A30	DC-3GHz	5W	30 dB	±0.8 dB	1.2	N-M / N-F	50 Ω
UIYCA5AN6A1	DC-6GHz	5W	1 dB	±0.6 dB	1.25	N-M / N-F	50 Ω
UIYCA5AN6A2	DC-6GHz	5W	2 dB	±0.6 dB	1.25	N-M / N-F	50 Ω
UIYCA5AN6A3	DC-6GHz	5W	3 dB	±0.6 dB	1.25	N-M / N-F	50 Ω
UIYCA5AN6A5	DC-6GHz	5W	5 dB	±0.6 dB	1.25	N-M / N-F	50 Ω
UIYCA5AN6A6	DC-6GHz	5W	6 dB	±0.6 dB	1.25	N-M / N-F	50 Ω
UIYCA5AN6A10	DC-6GHz	5W	10 dB	±0.8 dB	1.25	N-M / N-F	50 Ω
UIYCA5AN6A20	DC-6GHz	5W	20 dB	±1.0 dB	1.25	N-M / N-F	50 Ω
UIYCA5AN6A30	DC-6GHz	5W	30 dB	±1.0 dB	1.25	N-M / N-F	50 Ω

- 2 List are specify frequency range and other ranges available.
 2 Please enter below information when inquiry and mark * is must.
 * 1. Power handling, Attenuation Value
 2. Connect type (SMA Male/ Female, N Male/ Female, etc.)
 3. Other special request if have (VSWR, Temperature, Dimension, etc.)

Mechanical Drawing

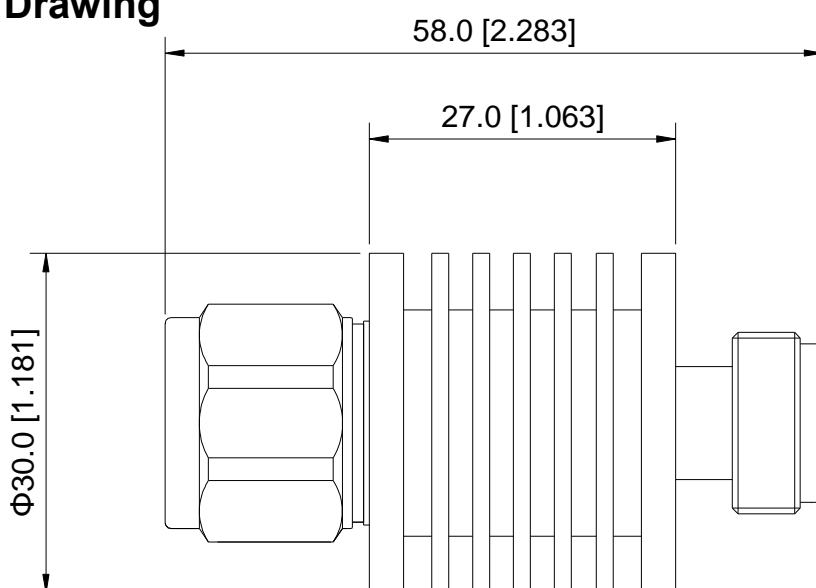

Unit: mm/ inch, General part tolerance is ±2% unless otherwise stated.

Ver. 5